

MAKE X

V1.0

ROBOTICS COMPETITION

RULES GUIDE MAKE X STARTER



2024.01

www.makex.cc



Date	Version	Modifications Record
2024.01	1.0	MakeX Starter All-Core Journey Rules Guide First Publish.

MAKE X



CONTENTS

1. Introduction	5
1.1 About MakeX	5
1.2 MakeX Spirit	5
1.3 About MakeX Starter	6
2. Competition Application	6
2.1 Participation Requirements	6
2.2 Registration and Application	7
3. Competition Procedure	7
4. Competition Details	10
4.1 Introduction	11
4.2 Arena	12
4.3 List of Props	14
4.4 Missions Introduction and Scoring State Judgement	20
4.5 Scoring Explanation	34
4.6 Single Match Flow	35
5. Technical Requirements	38
5.1 Robot General Specification	38
5.2 Team's Marker Specification	41
6. Rules of Competition	42
6.1 Penalty explanation	42
6.2 Safety	43
6.3 Operation	44
7. Appeal and Arbitration	50
7.1 Results Confirmation	50



7.2 Appeal Procedure and Valid Appeal Period 50

7.3 Invalid Appeal 51

7.4 Arbitration Procedure 52

8. Statement 53

 8.1 Rules Explanation 53

 8.2 Disclaimer 53

 8.3 Copyright Declaration 54

Appendix 1. Awards and Annual Points 55

Appendix 2. Engineering Notebook Guideline 57

Appendix 3. Robot Self-Check Form 59

Appendix 4. MakeX Starter Score Sheet 61

Appendix 5. Competition Resources 62

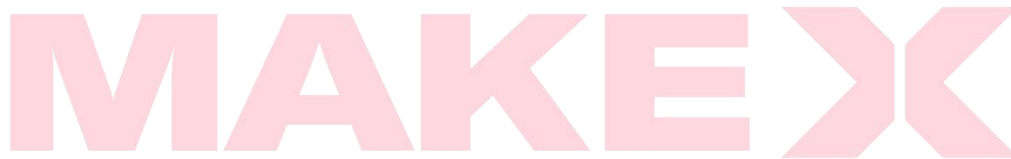

1. Introduction

1.1 About MakeX

MakeX is an international robotics competition and education platform that promotes multidisciplinary learning within the fields of science and technology. It aims at building a world where STEAM education is highly appreciated and where young people are passionate about innovation by engaging them in exciting Robotics Competition, STEAM Carnival, Tech Event, Educational Conference etc.

As the core activity of MakeX, the namesake MakeX Robotics Competition provides exciting, challenging and high-level competitions in the spirit of creativity, teamwork, fun and sharing. It is committed to inspiring young people to learn Science (S), Technology (T), Engineering (E), Art (A) and Mathematics (M) and apply such knowledge in solving real-world problems.

1.2 MakeX Spirit

Creativity: we advocate curiousness and innovation, encouraging all contestants to create unique high-tech works with their talent, and challenge themselves for continuous progress!

Teamwork: we advocate solidarity and friendship, encouraging all contestants to develop a sense of responsibility and enterprising spirit, and sincerely working with their partners for win-win development!

Fun: we encourage contestants to build a positive, healthy mindset in the competition. Enjoy the journey and grow in the process.

Sharing: we encourage contestants to have an open mind as a maker and share their knowledge, responsibility, and joy with everyone, including their teammates and competitors.

MakeX spirit is the cultural cornerstone of the MakeX Robotics Competition. We hope to provide a platform for all contestants, mentors and industry experts to



exchange ideas, study and grow up, and help young people acquire new skills during creation, learn to respect others in teamwork, gain an enjoyable life experience in the competition, take delight in sharing with the society their knowledge and responsibility, and work hard to achieve their grand aspiration of changing the world and creating the future !

1.3 About MakeX Starter

MakeX Starter is a multi-mission competition program for teenagers aged from 6-13. The competition integrates the automatic stage and the manual stage, which greatly enhances fun and participation experience of the competition. The concept of multiple missions and the alliance cooperation design fully exercises the abilities of critical thinking and strategic planning of contestants, as well as improve the ability of communication and cooperation between alliance teams.

2. Competition Application

2.1 Participation Requirements

Participants: The number of contestants is 1-2 for each team, with 1-2 mentor(s).

Age: Team members must be teenagers or children between the age of 6-13 (born between January 2, 2010 and December 31, 2018), the mentor must be at least 18 years old.

Team Roles: Everyone in the team can play their respective roles as operator, observer. The operator is responsible for operating the robot, and the observer is responsible for assisting the operator to complete the game.

Identification Symbols: Each team must have a team logo, team name, and team slogan. Teams are encouraged to use uniforms, flags, posters, badges, base decorations, etc. to show the team culture.

2.2 Registration and Application

Contestants and mentors that meet participation requirements can register on the designated competition web-page on MakeX official website (www.makex.cc/en). Each team should register with one registration form.

If participating team wants to change their members before competition, which leads to inconsistency with the registration information, they should inform MakeX Robotics Competition Committee in advance to finish re-registration.

For more details about the registration and application, please refer to [MakeX Registration & Competition Application Guide](#)

3. Competition Procedure

Participating teams shall pay close attention to related notices and Competition Guide published before each competition. If the rules have some updates in competition guide, the latest rules will be adopted for the competition. MakeX Competition Committee reserves the rights and final interpretation to amend competition rules and system based on actual situation of different competition.

The schedule for each competition is determined by actual situation, and generally includes following procedures.

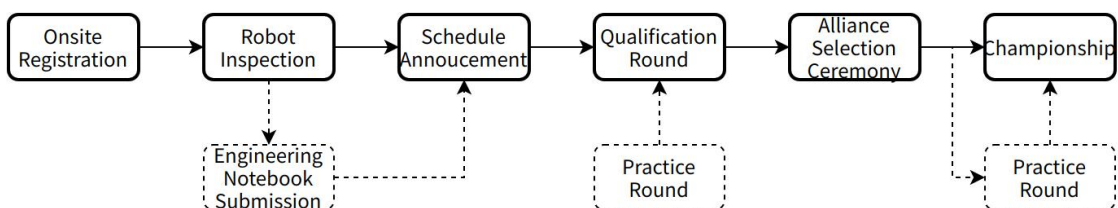

* Note: The solid line frame refers to necessary procedure of each match, while the dotted line frame refers to non-essential procedure. Please keep abreast of updates.

Onsite Registration

When a team arrives at the venue, mentors and contestants should show ID cards or other valid certificates (e.g., passport) for onsite registration and to get the



competition pack. It is necessary for mentors to inform team members about the fire exit, match schedule, arena, pits area, etc. Onsite registration and robot inspection will be closure once the match schedule is announced.

Robot Inspection

Teams are required to check their robots and team markers before the competition and complete the "**Appendix 3: Robot Self-Inspection Form**" according to the actual data. The inspectors will check the robot and team markers against the completed Robot Self-Inspection Form. Teams that do not provide the completed Robot Self-Inspection Form will not be accepted for inspection; Before the competition, the referee will randomly check the robots or the teams can check each other's robots, when the robots do not match the inspection requirements, the participating teams will be disqualified from this match.

Schedule Announcement

The committee will announce the match schedule at least 30 minutes ahead of competition through online official website and onsite announcement. The schedule includes match-up chart, match session and specific time, red alliance and blue alliance, etc. If two matches are too close, please sign-up at the Result Approval Area.

Engineering Notebook Submission

Each team is required to submit 1 paper copy of their teams' engineering notebook to the MakeX staff. If you are unable to submit the original version, please prepare your own copy. The engineering notebook will be used as an important basis for the selection of the special awards, and the paper version of the engineering notes will not be returned after submission. For suggestions on how to write the engineering notes, please refer to "**Appendix 2: Engineering notebook guideline**".

Practice Round

Teams who have finished their robot inspection can participate in practice round. The schedule will be announced at the entrance in form of notices, and teams are required to queue in line before entrance. Not all competitions have a practice round, which can be informed based on actual situation.

Waiting for the match

During regular matches, the venue will be equipped with the waiting area and Make staff will announce or post the number of waiting match in the pits area.

Participating teams should pay attention to the notification of waiting match and go to the corresponding waiting area according to the notified waiting matches.

Qualification Round

Normally, each team will participate in 4 matches during Qualification Round in a regular competition, during which alliances teammate will be allocated randomly. The number of qualifications matches for teams to participate in may vary between different competitions, which is decided by the MakeX Committee according to the practical situation.

Teams will be ranked according to the below principal after Qualification Round:

- (1) Rank according to the sum of teams scores from all qualification rounds, the team with the higher total qualification round score will have higher ranking;
- (2) If the above condition is same, team with shorter total completion time during the qualification round rank higher;
- (3) If the total score and completion time of qualification round are the same, two teams who rank the same will have an additional match (only for the automatic independent missions), until the winner is decided.

Promotion proportion for each competition

In the 2024 season, the promotion proportion for each competition is 50%. Take up even teams to advance.

Example: the actual participating teams are 129, $129 \div 2 = 64.5$, then take an even number of teams up and promote to 66 teams.

Alliance Selection Ceremony

During the alliance selection ceremony, promoted teams will select their alliance team in turn according to their ranking in qualification round. During this procedure, teams must abide by following rules:

When being chosen by other teams, promoted teams ranking top 50% can refuse for



only once, and those teams ranking bottom 50% cannot refuse. If the team is refused by another team, they can continue to choose another team until the alliance is formed.

The promoted teams who are not present before the start of alliance selection are deemed as voluntarily giving up the right to choose alliance, and those who are not present before the end of the alliance selection are considered to be as voluntarily quitting the championship round. If the promoted teams quit amid the alliance selection ceremony, the promotion places will be given to the following teams according to the ranking in the qualification round.

During the alliance selection ceremony, each team representative will have 30 seconds to make their decision when it is their turn, and if they are not selected within the 30-second time limit, they will lose the right to select and will move on to the next team in order.

Championship Round

Normally, each alliance will participate in 2 match during Championship Round in a regular competition. The number of championship match may be increased or decreased depending on the actual situation of different competition. Red and blue teams will be chosen by alliance teams themselves. The alliance teams will be ranked according to the following rules.

- (1) The alliance with the higher score of the single match will rank higher.
- (2) If the score of the match is equal, the alliance with the shorter completion time ranks higher.
- (3) If the above conditions are the same, the alliance with the same ranking will complete an extra match (finish all the missions) until the winner is decided.

4.Competition Details

The theme of the 2024 MakeX Starter is "All-Core Journey".



The traditional manufacturing industry consumes a lot of manpower and material resources, resulting in numerous waste emissions and even leading to pollution of the environment. Chip equipped with advanced technology is the technology leading the change of manufacturing industry, which will greatly enhance the manufacturing efficiency, reduce manufacturing costs, and improve the intelligence and convenience of manufacturing. The teenagers have a keen insight into the first opportunity and improvement of intelligent manufacturing, and they are determined to explore the core to find the treasure, and go on the all-core journey to contribute the core power for the future of intelligent manufacturing, and to promote the sustainable development of the intelligent manufacturing industry.

4.1 Introduction

MakeX Starter is a multi-mission-based competition and requires blue and red teams forming an alliance to participate.

The competition lasts 4 minutes and is divided into automatic stage and manual stage. The teams in the alliance can decide the time for each stage. There are 2 scoring times in each match. Teams shall complete the automatic mission during the automatic stage, when both teams in the alliance agree to switch from the automatic stage to the manual stage, the referee will stop the timing and the competition enters the scoring time after the automatic stage. After scoring, the manual stage begins and teams shall complete the manual mission during the manual stage. After the end of a single match, the competition enters the scoring time after the manual stage, the referee calculates the scoring for each stage according to the status of props at the scoring period.

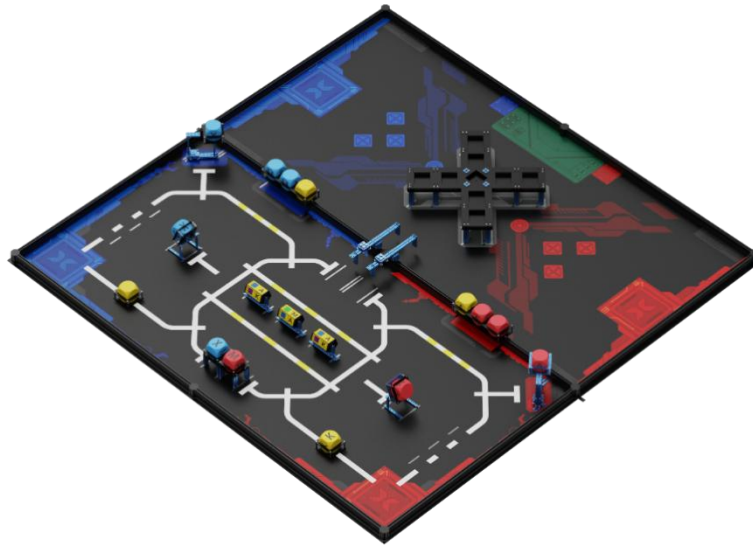

Fig4.1 Competition Arena Isometric View

4.2 Arena

MakeX Starter Arena consists of map and frame. Internal size of frame is 2317mm*2317mm, external size of frame is 2372mm*2372mm.

The map is consisting of two parts, including the automatic mission area and manual mission area, together with starting area, marking area, manual loading area and resource area.

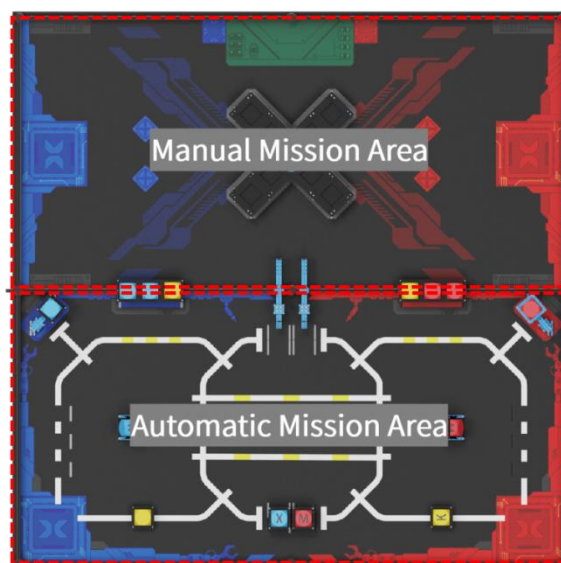

Fig4.2-1 Areas on the Competition Arena

Arena in details:

Starting Area

There is one red and one blue starting area in automatic mission area, in which is a rectangle with a side length of 280mm.

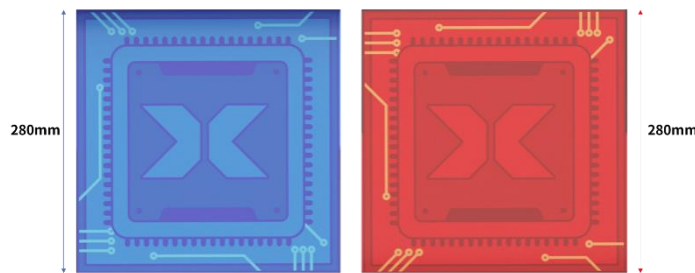

Fig4.2-2 Starting Areas in the Automatic Mission Area

There is one red and one blue starting area in manual mission area, in which is a rectangle with a side length of 280mm.

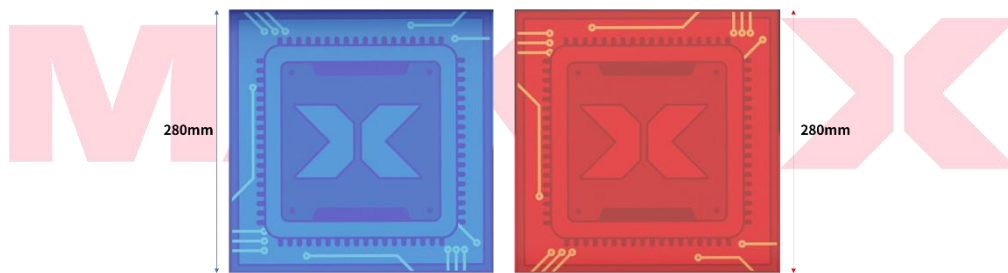

Fig4.2-3 Starting Areas in the Manual Mission Area

Password filling area

The password filling area is the area shown below.

Size: length 130mm* width 93mm

Location: Beside the T-intersection in the central area of the automatic mission area

Amount: 1 for each red and blue side

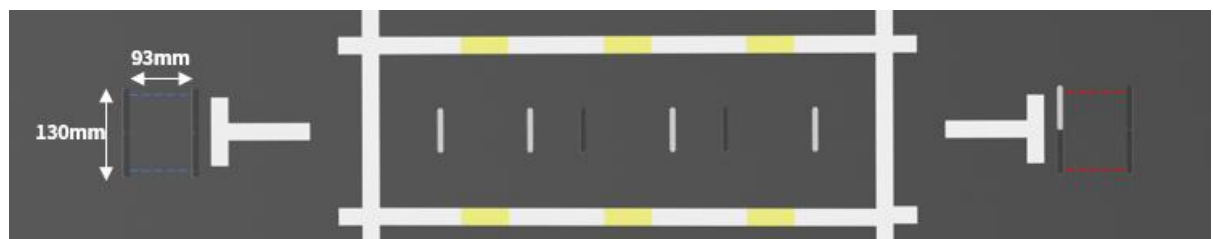

Fig4.2-4 Password filling area

Manual Loading Area

Green area shown below is Manual Loading Area.

Size: length 550mm* width 200mm

Location: On one side of the Manual Mission Area

Amount: 1



Fig4.2-5 Manual Loading Area

Marking Area

Two circle shape areas shown in following Fig 4.2-5 are Marking Areas.

Size: Diameter 60mm Circle

Location: On both side of the Matrix Research Station in the Manual Mission Area

Amount: 1 for each red and blue team

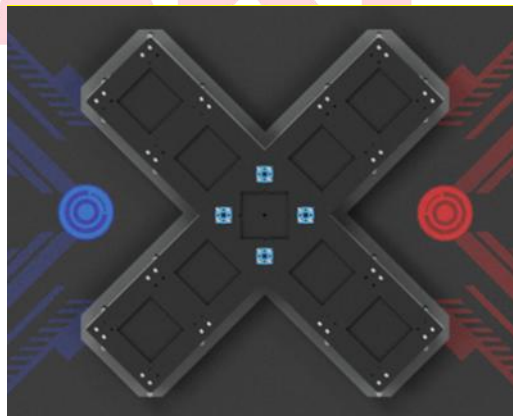

Fig4.2-6 Marking Area

4.3 List of Props

Props include scoring props and mission props; the following is the introduction of props:

Scoring Props:

Name: Data Cube

Introduction: Red or blue round corner cube with the side of 70mm, 4 sides are labeled with the alphabet "M", "A", "E" and "X", hereinafter referred to as red/blue alphabet cube.

Size: maximum size length is 70mm

Color and Material: Red, Blue, EVA



Fig4.3-1 Data Cube

Name: Quantum chip

Introduction: Yellow round corner cube with the side of 70mm, 4 sides are labeled with the alphabet "K", hereinafter referred to as yellow alphabet cube.

Size: maximum size length is 70mm

Color and Material: Yellow, EVA



Fig4.3-2 Quantum Chip

Name: Organic Crystal

Introduction: Yellow round corner cube with the side of 70mm, hereinafter referred to as yellow cube.

Size: maximum size length is 70mm

Color and Material: Yellow, EVA

**Fig4.3-3 Organic Crystal**

Name: Team Marker

Introduction: It is a 3D prop, no limitation of material, recommended to use laser cutting machine or 3D printer to produce. The height should not be greater than or equal to 120mm, and the vertical projection on the ground should not be greater than or equal to a circular area with a diameter of 60mm.

Size: Height \geq 120mm, vertical projection of the prop \geq circular area with a diameter of 60mm

Color and Material: No limitation.

Mission prop

Name: Logistics Distributor

Introduction: A shaped structure made of blue metal parts, with a part of the platform that can be moved in parallel to place with a red or blue alphabet cube.

Size: 165*96*176mm (length, width, height)

Color and Material: blue metal parts, black acrylic

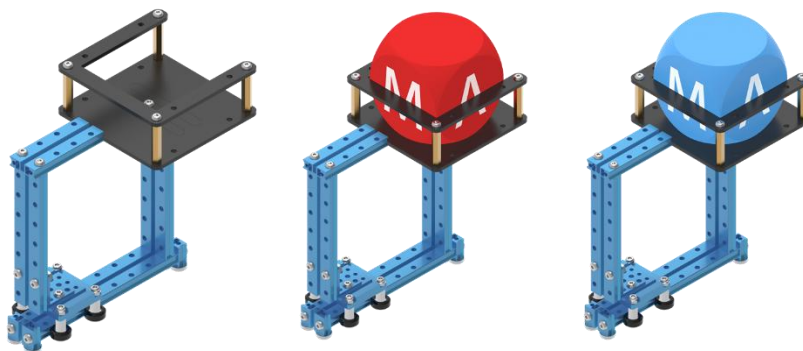
**Fig4.3-4 Logistics Distributor**

Name: Antimatter Fuel Rods

Introduction: Rotatable device consists of 5 sides, each of which is labeled with a "color mark" and "alphabet". One side of the device always keeps facing up for each time it rotated.

Color and Material: blue metal parts, black acrylic

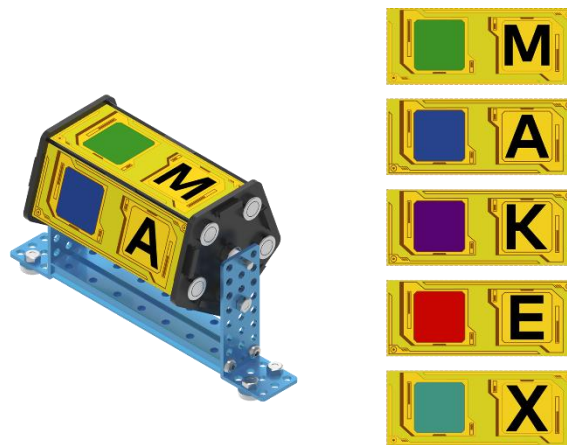

Fig4.3-5 Antimatter Fuel Rods

Name: Higher Manufacturing Table

Introduction: Table that made of blue metal and black acrylic, can be embedded with cubes that maximum side length is 70mm; Its platform is unmovable.

Size: 96*96*100mm

Color and Material: blue metal parts, black acrylic

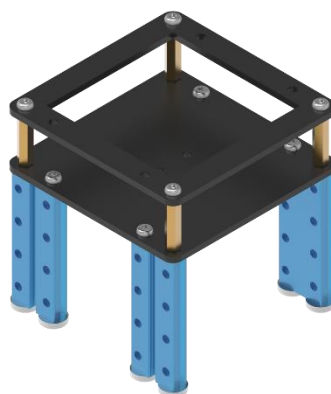

Fig4.3-6 Higher Manufacturing Table

Name: Lower Manufacturing Table



Introduction: Made of black acrylic. The base is movable. A magnet attraction sheet is stick to the bottom for placement on a magnet;

Size: 96*96*42mm

Color and Material: metal parts, black acrylic

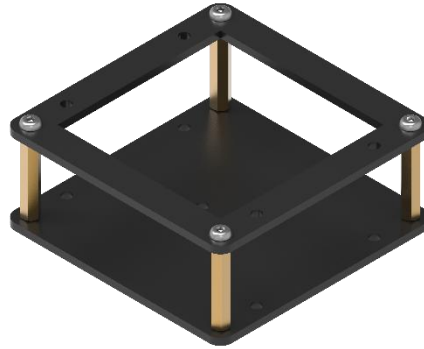

Fig4.3-7 Lower Manufacturing Table

Name: Resource Converter

Introduction: Made of blue metal and black acrylic. The base with embedded cubes can be rotated, and the cube can be placed under the base to make the base horizontal;

Size: 108*124*157mm

Color and Material: blue metal parts, black acrylic



Fig4.3-8 Resource Converter

Name: High-speed sorter

Introduction: A shaped structure made of blue metal parts, located at the central frame of the arena. With a slide device that allows the lower manufacturing table to be placed on the slide and slid into the manual area.

Size: 300*50*78mm

Color and Material: blue metal parts

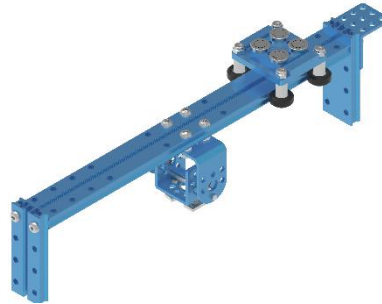

Fig4.3-9 High-speed sorter

Name: Storeroom

Introduction: Construct with black wooden board and metal parts, located at the central frame of the arena. On the top is the wooden board that can be embedded with cubes, which can hold 3 cubes with a maximum side length of 70mm.

Size: 288*96*44mm

Color and Material: black wooded board



Fig4.3-10 Storeroom

Name: Matrix Research Station

Introduction: Made of black wooden board and metal parts. On the top is the wooden board that can be embedded with alphabet cubes, which can hold 9 cubes with a maximum side length of 70mm.

Size: 620*620*110mm



Color and Material: blue metal parts, black wooded board

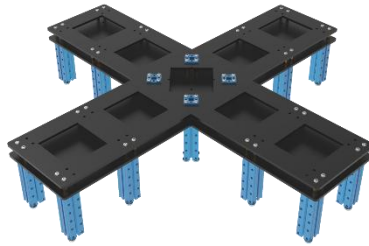

Fig4.3-11 Matrix Research Station

*Note: All arena and props have some reasonable tolerance.

4.4 Missions Introduction and Scoring State Judgement

Participants will engage in various missions, including Independent Missions, Alliance Missions, and potential Mysterious Missions.

Independent Mission: Designated as M01-M06, the scores for Independent Missions are exclusively attributed to the respective team undertaking the mission.

Alliance Mission: Identified as M07-M09, Alliance Missions require collaborative efforts, and the resulting scores are collectively awarded to the two teams forming the alliance.

Mysterious Mission: This mysterious mission is unveiled exclusively during major competition events, adding an element of surprise and strategic complexity.

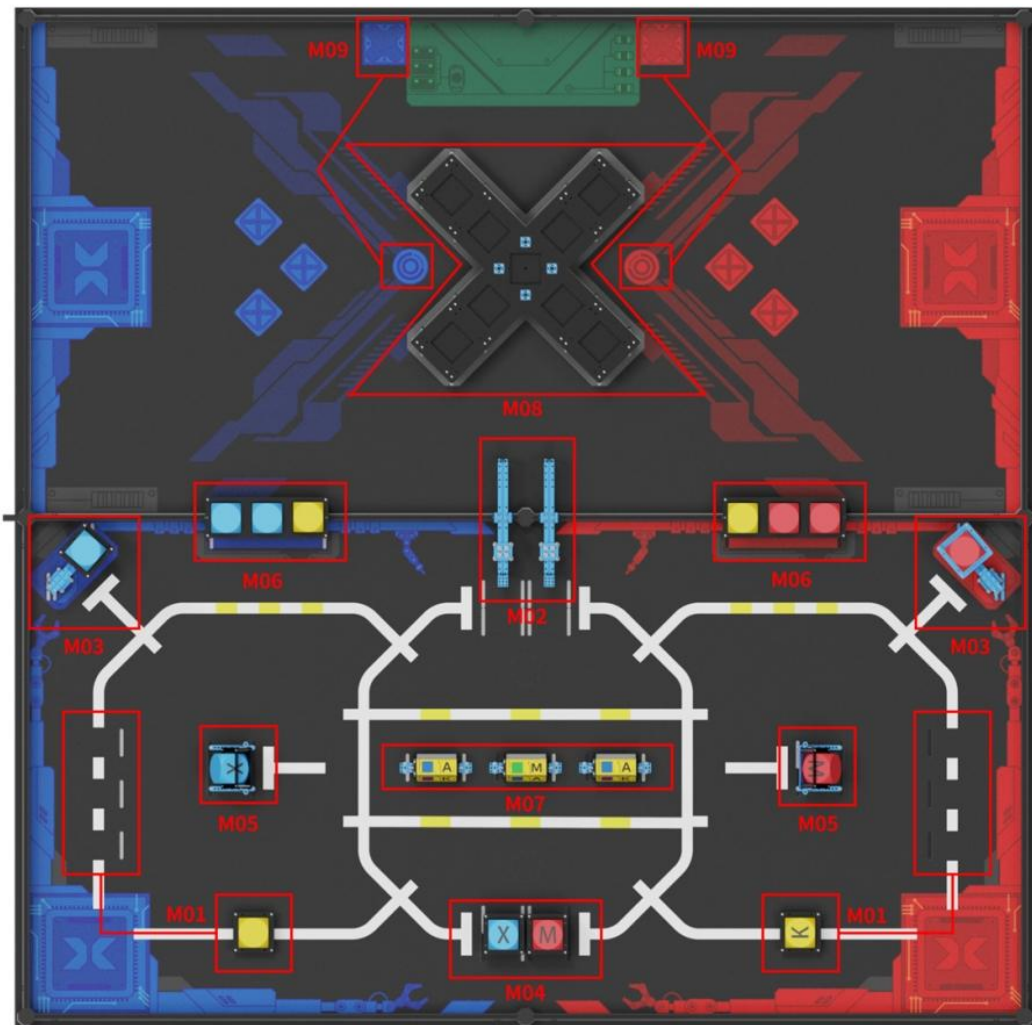

Fig4.4-1 Missions in the automatic and manual area

In a single match, each team is required to complete 6 independent missions, 3 alliance missions:

Stage and Time	Mission Type	Mission Name
Automatic Stage (Duration: x seconds, where $0 < x \leq 240$)	Independent Mission	M01: Capturing Quantum Chip
		M02: Transiting Quantum Chip and Organic Crystal
		M03: Capturing Alphabet Cube
		M04: Intelligent Manufacturing
		M05: Processing of Contaminants
		M06: Stacking Storeroom



Automatic Stage (x seconds, 0<x≤240)	Alliance Mission	M07: Lighting the Antimatter Fuel Rods
Manual Stage (240-x Seconds)	Alliance Mission	M08: Operating Matrix Research Station
		M09: Placing Team Marker

M01 Capturing Quantum Chip

Mission Type: Independent Mission

Mission Background: The quantum chip, a crucial sensor type, serves as a fundamental component within the smart factory ecosystem. Its primary function involves the collection and transmission of various factory metrics, including temperature, humidity, pressure, vibration, and electricity. These data are relayed to the factory's digital management system via the internet, thereby facilitating comprehensive factory monitoring through advanced sensor technology.

The mission necessitates that the robot meticulously relocate the quantum chip (symbolized by a yellow alphabet cube) and the organic crystal (represented by a yellow cube), along with their respective bases, from their initial positions. This mission requires precision and care to ensure complete removal from the designated start area.

Starting Condition: The alliance must decide whether to position the yellow alphabet cube in either the red or blue designated area. The mission's commencement is characterized by four initial areas. The placement of the yellow alphabet cube (marked distinctly with the letter "K" facing upwards) or the yellow cube, along with their bases, is pre-determined through a random drawing prior to the match. One of the potential arrangements is depicted below. Notably, the scoring props are not permanently affixed to the arena.

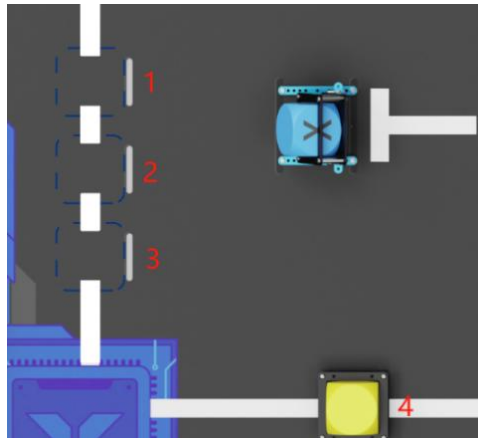

Fig4.4-2 M01 initial placement

Mission Score: The successful removal of each cube and its base from the start area is valued at 20 points

Scoring Judging: At the scoring time after automatic stage:

- a. The vertical projection of yellow alphabet cube or yellow cube, including the base is completely moved out of the initial area.
- b. The yellow alphabet cube or yellow cube, including the base must be completely located in the arena.
- c. The yellow alphabet cube or yellow cube is not separated from the base.
- d. The yellow alphabet cube or yellow cube, including the base has no contacted with the robot.

All these conditions must be met simultaneously for points to be awarded.

Arena Definition: The arena encompasses the map, the upper surface, and the internal edges of the frame. It explicitly excludes the external surface of the frame, the desktop, the ground, and any other adjacent areas.

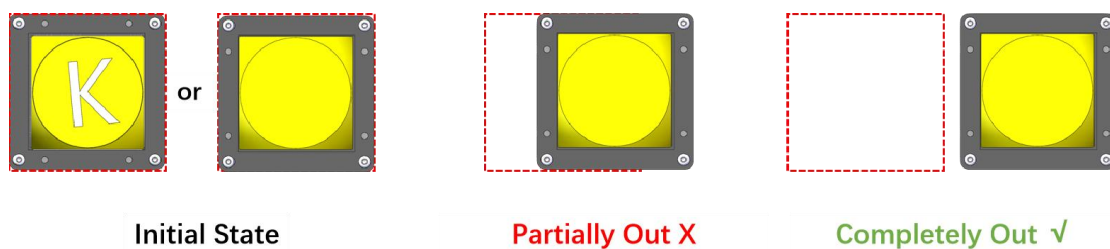

Fig4.4-3 M01 Scoring Judging



M02 Transiting Quantum Chip and Organic Crystal

Mission Type: Independent Mission

Mission Background: Intelligent logistics significantly enhances the efficiency and precision of factory operations.

This mission mandates robots to meticulously transport the organic crystal (represented by a yellow cube) or the quantum chip (symbolized by a yellow alphabet cube), along with their bases, to the designated transfer area. This transfer is facilitated by a high-speed sorting mechanism and a transfer slide device, ensuring the secure attachment of the completed products and sensors to the transport skids.

Starting Condition: The transfer slide device is strategically mounted on the flat beam, bridging the manual and automatic mission areas. The configuration ensures that the pulley block is positioned entirely within the automatic mission area, while the slide device inclines towards the manual mission area. Additionally, the pulley block is outfitted with magnets, a feature that guarantees a stable link between the cube base and the pulley block. The mission's scoring items, namely the yellow alphabet cube or the yellow cube (inclusive of the base), originate from mission M01.

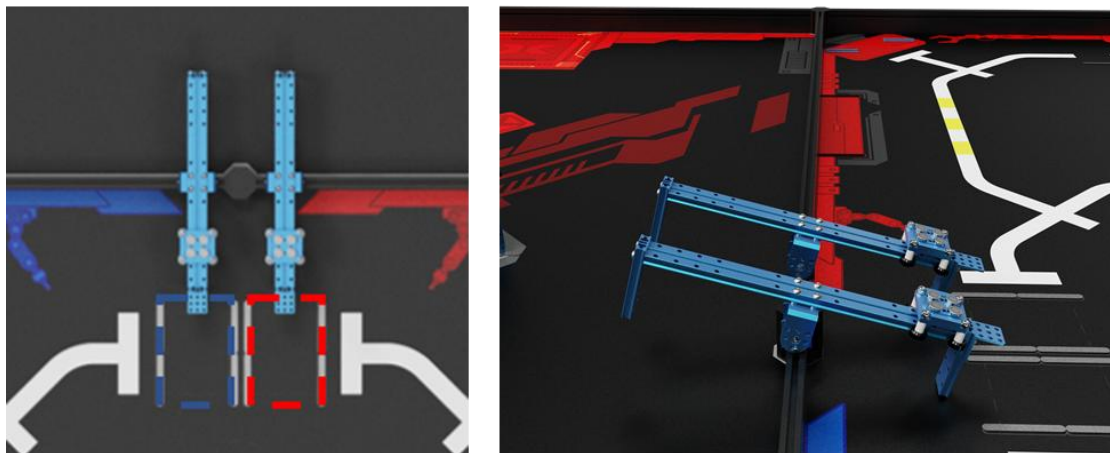

Fig4.4-4 M02 initial placement

Mission Score: Each successful removal of yellow alphabet cube or yellow cube (including the base) to the manual mission area counts for 30 points.

Scoring Judging: At the scoring time after automatic stage:

- The vertical projection of yellow alphabet cube or yellow cube, including the

base completely in the manual mission area.

b. The yellow alphabet cube or yellow cube, including the base shall be securely affixed to the pulley block.

c. The robot has not directed contact with the transfer slide device and the yellow alphabet cube or yellow cube and including the base.

All these conditions must be met simultaneously for points to be awarded.

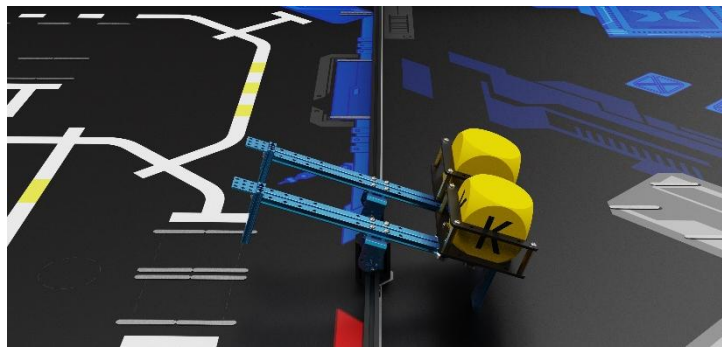

Fig4.4-5 M02 Scoring Judging

M03 Capturing Alphabet Cube

Mission Type: Independent Mission

Mission Background: In the manufacturing landscape, the purification and treatment of waste and wastewater are imperative. Simultaneously, the automated operations of factories rely heavily on data cubes.

Robots are tasked with employing the Logistics Distributor (a cube ejection mechanism) to acquire the blue and red alphabet cubes. This process is essential for categorizing and processing pollutants produced during manufacturing. Furthermore, the logistics dispenser is utilized for sorting the factory's outputs, pollutants, and chips, thereby securing more eco-friendly alphabet cubes.

Starting Condition: The logistics distributors are positioned in the upper left quadrant of the start area, delineating the red and blue areas. Each device platform hosts a red or blue alphabet cube, with its open face oriented towards the manual area. The cube removal device's base is securely attached to the map with magnets, featuring two double-hole beams. The logistics dispenser's placement, exemplified

on the blue side, aligns with the magnetic stripe markings on the map, denoted as a, b, and c. Correspondingly, the circular magnetic disk markings on the logistics distributor's base, labeled A, B, and C, dictate specific placements: disk A on the red point of magnetic stripe A, disk B on magnetic stripe b, and disk C on magnetic stripe c.

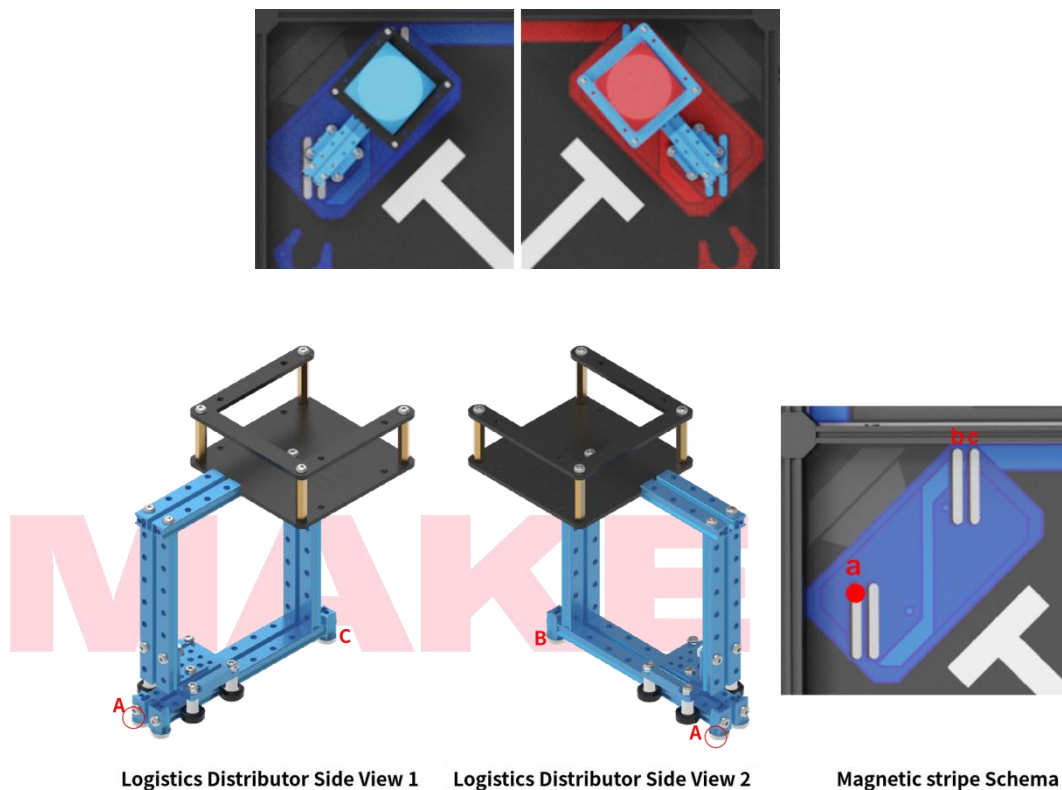

Fig4.4-6 M03 initial placement

Mission Score: Each successful removal of red or blue alphabet cube from the logistics distributor counts for 30 points.

Scoring Judging: At the scoring time after automatic stage:

- The vertical projection of red or blue alphabet cube is completely in the manual mission area.
- The red or blue alphabet cube has not directed contact with the cube push-off device.
- The red or blue alphabet cube has not directed contact with the robot.
- The cube push-off device stays upright.

All these conditions must be met simultaneously for points to be awarded.

M04 Intelligent Manufacturing

Mission Type: Independent Mission

Mission Background: After sorting, the goods are required to be methodically stacked for preservation. Robots are tasked with stacking these sorted items on the elevated manufacturing table (high placement table) and retrieving the alphabet cube from the same for future operations.

Starting Condition: The elevated manufacturing tables are positioned in the central area of the automated mission area, adjacent to the lower frame. Their four pillars are magnetically secured to the map, ensuring their vertical projections are confined within the map's dotted box. A red or blue alphabet cube is integrated into the platform of each elevated manufacturing table. The specific orientation of the alphabet cube, marked with either "M" or "X," is determined prior to the match through a draw of prop cards.

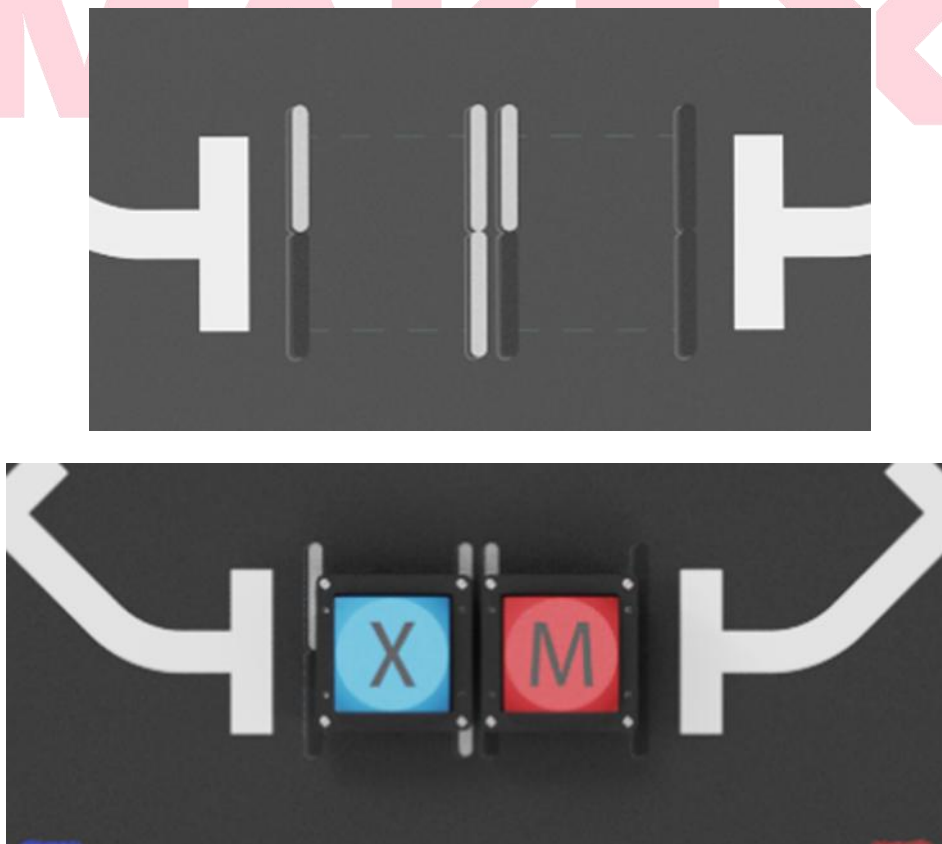

Fig4.4-7 M04 initial placement



Mission Score: Each successful removal of alphabet cube counts for 20 points.

Scoring Judging: At the scoring time after automatic stage:

- a. The alphabet cube is completely detaching with the high placement table.
- b. The vertical projection of the red or blue alphabet cube must be completely located in the arena.
- c. The red or blue alphabet cube has not direct contact with the robots and the high placement table.

All these conditions must be met simultaneously for points to be awarded.

M05 Processing of Contaminants

Mission Type: Independent Mission

Mission Background: The mission necessitates the robot transporting the data cube (a red or blue alphabet cube) retrieved from the higher manufacturing table to the password filling area, thereby enabling the pollution treatment device to process wastewater. The mission further involves relocating the red or blue alphabet cube positioned in the device's mounting to the manual area.

Starting Condition: Within the automatic mission area, each red or blue area houses a password-filling area. Situated within this area is a resource transition device, embedding a red/blue alphabet cube. The device's platform is elevated, presenting the initial state as illustrated below. The robot's objective is to relocate the alphabet cube, denoting the password components "M" or "X," into the password filling area, thus fulfilling the password input mission. Additionally, it involves the exchange and relocation of the red or blue alphabet cube from the resource transition device to the manual area.

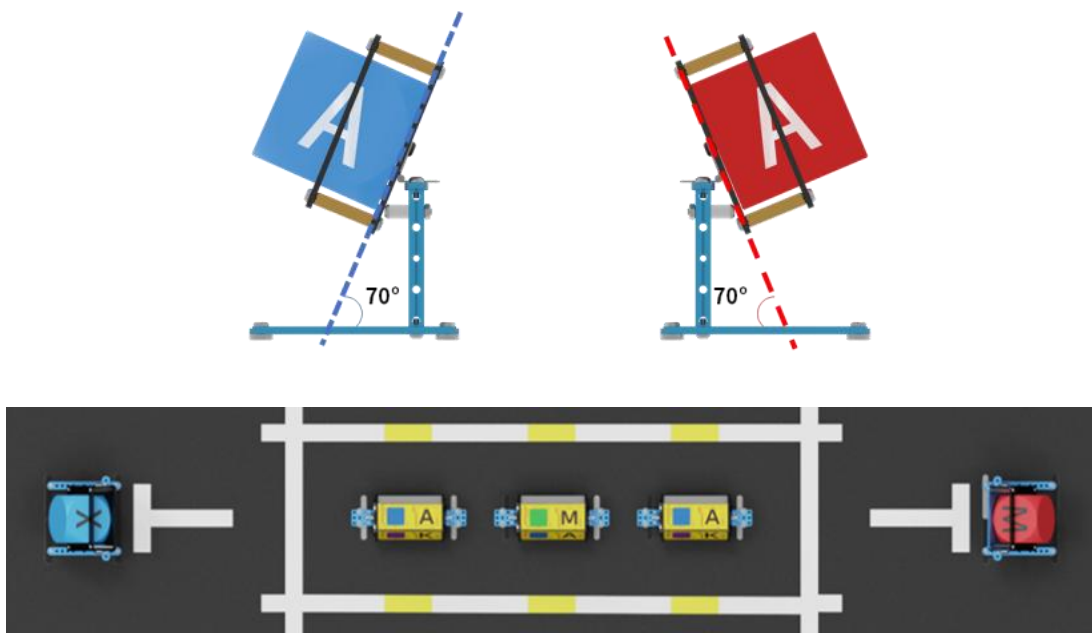

Fig4.4-8 M05 initial placement

Mission Score: Each password filling area functions as a scoring area. Successfully placing the red or blue alphabet cube, representing the password components "M" or "X," into the password entry area earns 10 points.

Successfully moving the red/blue alphabet cube, initially embedded in the resource transition device, to the manual area is awarded 30 points.

Scoring Judging:

1. At the scoring time after automatic stage:

- a. The vertical projection of the red or blue alphabet cube at least partially enters the password-filling area and is in direct contact with the arena.
- b. The red or blue alphabet cube has not direct contact with the robots.
- c. The alphabet cube's "X" or "M" side must be upward-facing, aligning with the initial orientation of the alphabet cube from M04.

All these conditions must be simultaneously met for the corresponding red or blue alphabet cube to be considered valid for scoring to be valid.

2. At the scoring time after automatic stage: the vertical projection of the red or blue alphabet cube that embedded in the resource transition area is completed in the manual area.

Above conditions must be fulfilled at the same time for scoring.



M06 Stacking Storeroom

Mission Type: Independent Mission

Mission Background: The mission involves the robot identifying and selecting the red or blue alphabet cube from the storeroom, amidst a mixture of organic crystals (yellow cubes), and conveying them to the manual mission area. The mission mandates the retention of the organic crystal (yellow cube) within the storeroom.

Starting Condition: The storeroom houses two alphabet cubes, each matching the respective side's color, and one yellow cube. The position of the yellow cube is determined based on the prop cards drawn prior to the match.

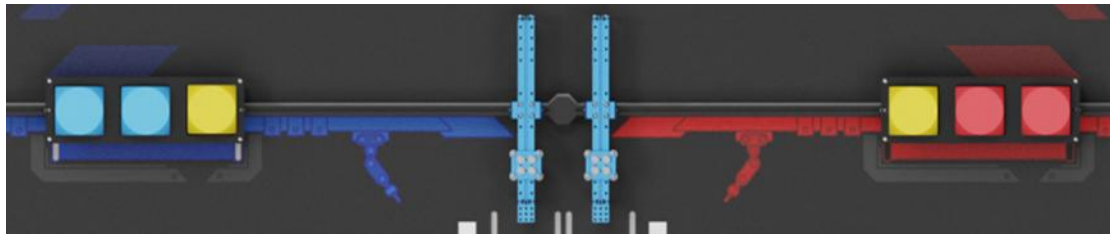

Fig4.4-9 M06 initial placement

Mission Score: Each correct pick of cube counts 30 points; the yellow cube stay on the initial area counts 10 points.

Scoring Judging: At the scoring time after automatic stage:

a. The vertical projection of the red or blue alphabet cube is completely in the manual area.

b. The vertical projection of yellow cube is completely in the storeroom.

Above all conditions fulfilled at the same time, the relevant cube is valid.

M07 Lighting the Antimatter Fuel Rod

Mission Type: Alliance Mission

Mission Background: Antimatter fuel rods have the advantages of high efficiency, intelligence and durability. The continuous intelligent operation of the factory needs fuel rods for supporting. The robot is required to automatically toggles the antimatter fuel rods to make the factory facilities run in an orderly manner.

Starting Condition: Three Antimatter Fuel Rods (rotary cylinders) are horizontally

positioned in the center of the automatic mission area. Each cylinder has five sides, each marked with a specific color and alphabet. The initial sequence of the cylinders is set according to the prop cards drawn prior to the match, with one potential arrangement depicted below. The rotary cylinders are required to align with the "|" part of the T-intersection, as shown below.

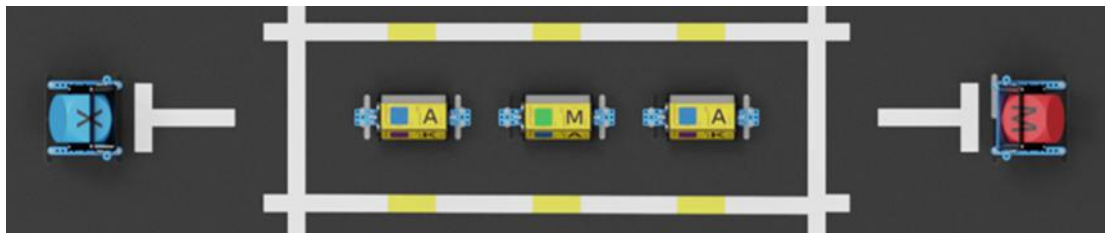

Fig4.4-10 M07 initial placement

Mission Score: Each cylinder array in the correct order, counts 30 points.

Scoring Judging: At the scoring time after automatic stage:

- a. The sequence of the rotary cylinder, when combined with the "X" and "M" cubes from M05, must spell "MakeX" in the correct order or "XEKAM" in reverse.
- b. The robot must not have any direct interaction with the rotary cylinder.
- c. The rotary cylinder must be arranged in a specific sequence with the key information side prominently facing upwards.

All these conditions must be met simultaneously for points to be awarded.

Note: If the "X" and "M" cubes in M05 do not score, the rotary cylinders will not collect any points, regardless of their sequence. If only one side scores in M05, the order of the cylinders in M07 should commence with the scoring side from M05, forming either a positive or negative sequence spelling "MakeX".

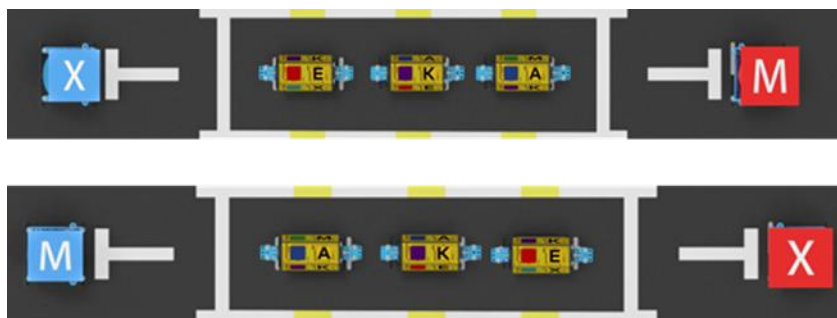

Fig4.4-11 M07 initial placement

M08 Operating Matrix Research Station

Mission Type: Alliance Mission

Mission Background: Designed to revolutionize digital factory management, industrial Internet devices are designed to collect a myriad of factory data such as temperature, humidity, pressure, vibration, and electricity. Robots are tasked with embedding quantum chips and data cubes into the Matrix Research Station. This information is relayed to the station via the Internet, enabling the monitoring of factory operations and the advancement of research into energy-efficient, intelligent manufacturing methods, ultimately elevating industrial production to a new level.

Starting Condition: In the manual area, there are no alphabet cubes initially. They are entirely contingent upon whether the red and blue teams have successfully transferred the corresponding props to the manual area during the automatic stage.

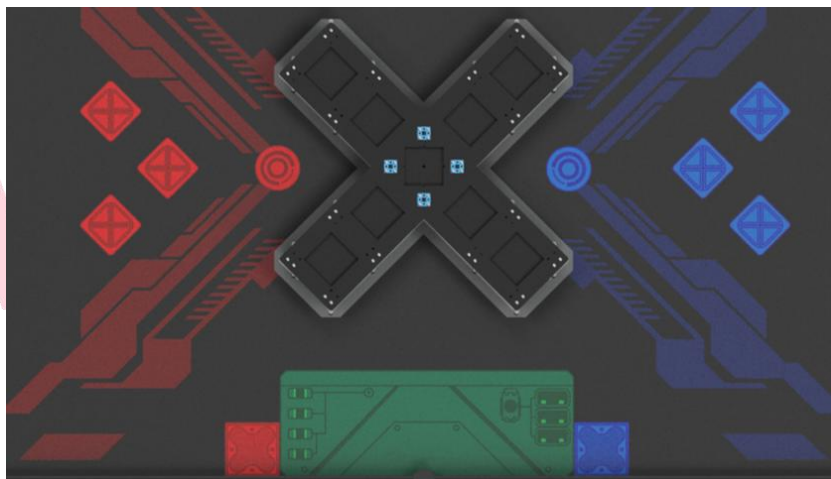

Fig4.4-12 M08 initial placement

Mission Score: Embedding each cube in the correct sequential color earns 20 points. Furthermore, if cubes of the same color are arranged in a "MakeX" sequence, an additional 50 points are awarded for each complete "MakeX" sequence.

Scoring Judging: At the scoring time after manual stage:

- a. Alphabet cubes must be accurately embedded in the designated sequence and color, aligned with the demonstrated order (as viewed from the manual loading area).
- b. The robot has no direct contact with red, yellow and blue alphabet cubes and yellow cube and any part of the storage rack(Matrix Research Station);

The red, yellow, and blue alphabet cubes must be fully integrated into the notches of the storage rack.

All these conditions must be met simultaneously for points to be awarded.

Note: Observers are permitted to interact with the alphabet cubes in the manual loading area but are prohibited from manually placing the cubes on the robot or having any direct or indirect contact with the robot in the manual loading area.

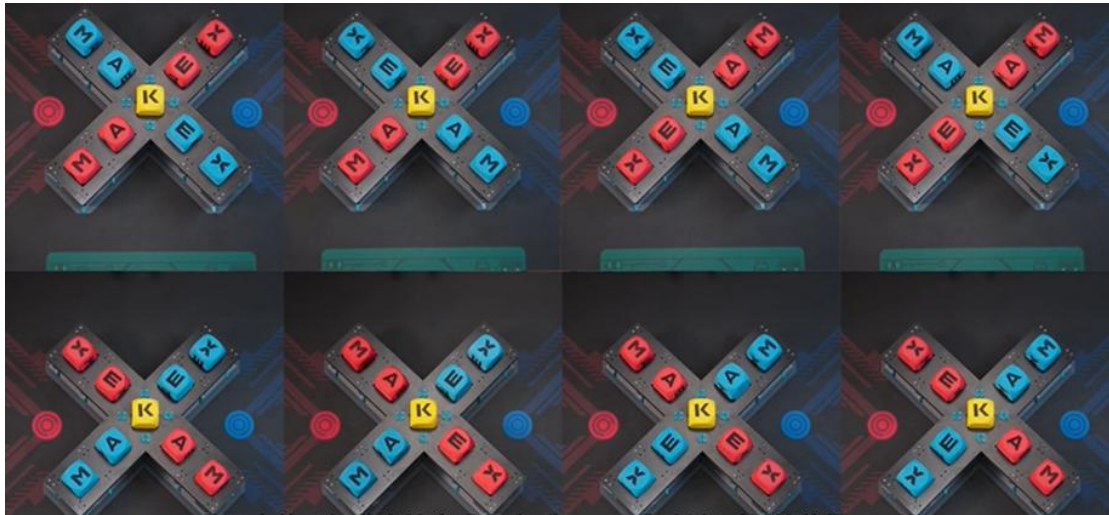

Fig4.4-13 M08 Scoring State

M08 Placing Team Marker

Mission Type: Alliance Mission

Mission Background: Markers play a crucial role in aiding manufacturing personnel to quickly operate a factory's smart manufacturing system. Robots are tasked with transporting and situating markers in the designated marking area.

Starting Condition: Prior to match commencement, contestants are to place their team markers within the marking area on both sides of the manual loading area. The team markers, which are the contestants' own props, must have their vertical projection fully within the square marking area. The markers must meet specific dimensions: a height of $\geq 120\text{mm}$ and a vertical projection area of $\leq 60\text{mm}$ in diameter within a circular space.

Mission Score: each successfully place of team marker counts 50 points;

Scoring Judging: At the scoring time after manual stage:

- a. The vertical projection of team marker is completed in the designate circle

area.

- b. The marker shall keep upright position and has no contact with robot.
- c. The team marker is in direct contact with the arena.

All these conditions must be met simultaneously for points to be awarded.

Note: All these conditions must be met simultaneously for points to be awarded.

Mysterious Mission

In different competitions, there may exist mysterious missions that different with existing mission(M01-M09); Details of mysterious mission may be published in the competition guide before the competition.

4.5 Scoring Explanation

Referee is counting the scores only in two scoring times, in which are after automatic stage and after manual stage. During the match, referee is monitoring the process and record warning and violation.

Independent Mission Score

Mission	Scoring Prop	Single Prop Score	Maximum Score
M01 Capturing Quantum Chip	<ul style="list-style-type: none"> ● Yellow Alphabet Cube(with base) ● Yellow Cube(with base) 	20 points/each	20 points
M02 Transiting Quantum Chip and Organic Crystal	<ul style="list-style-type: none"> ● Yellow Alphabet Cube(with base) ● Yellow Cube(with base) 	30 points/each	30 points
M03 Capturing Data Cube	Red/Blue Alphabet Cube	30 points/each	30 points
M04 Intelligent Manufacturing	Red/Blue cube with "M" or "X" Face-up	20 points/each	20 points
M05 Processing of Contaminants	<ul style="list-style-type: none"> ● Red/Blue cube "M" or "X" Face-up ● Red/Blue Alphabet Cube 	<ul style="list-style-type: none"> ● 10 points/each ● 30 points/each 	<ul style="list-style-type: none"> ● 10 points ● 30 points
M06 Stacking Storeroom	<ul style="list-style-type: none"> ● Red/Blue Alphabet Cube ● Yellow Cube 	<ul style="list-style-type: none"> ● 30 points/each ● 10 points/each 	<ul style="list-style-type: none"> ● 60 points ● 10 points

Alliance Mission Score



Mission	Scoring Prop	Single Prop Score	Maximum Score
M07 Lighting the Antimatter Fuel Rod	Rotary cylinder that meets the scoring judging	30 points/each	90 points
M08 Operating Matrix Research Station	<ul style="list-style-type: none"> ● Red/blue alphabet cubes that meets the scoring judging ● Completion of two "MAKEX" arrangements 	<ul style="list-style-type: none"> ● 20 points/each ● 50 points/set 	<ul style="list-style-type: none"> ● 180 points ● 100 points
M09 Placing Team Marker	Self-made props that meet specifications	30 points/each	60

After single match, referee will confirm the scoring with teams. Score contains three parts: independent mission, alliance mission and violation deduction. Single match score will be recorded for the ranking of qualification or championship round.

Qualification Match:

Single match score: self-team independent mission scores + alliance mission scores – violation deduction

Maximum scores= 210+470-0=640

Championship Match:

Single match score: red team independent mission scores + blue team independent mission scores + alliance mission scores – violation deduction

Maximum scores = 210+210+470-0=850

4.6 Single Match Flow

The single match lasts for 240 seconds. For any team, the match stages and switching time are as follows:

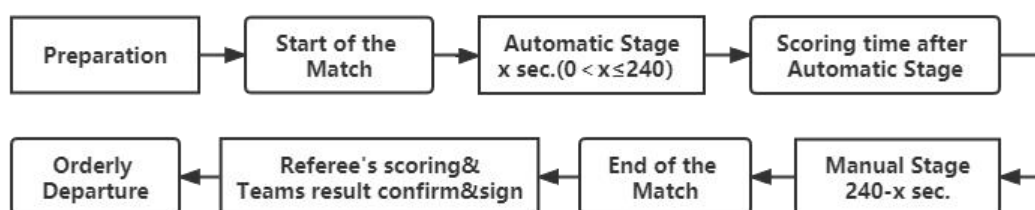



Preparation

Before the single match, contestants should arrive to the competition area ahead of schedule, and make preparations under the guidance of the referee.

- (1) Power on the robot and place it completely in the starting area in the automatic mission area. With Blue-tooth controller powering on and placing in the starting area in the manual mission area or outside the arena. Place the team self-made marker in the square marking area beside the manual loading area that inside the manual mission area.
- (2) One representative will be appointed by their team to draw a prop card and then place the props of M01, M04, M06 and M07 accordingly;
- (3) Check the standard of arena and props placement.
- (4) Waiting for the referee's order.

Automatic Stage

The automatic stage begins after referee's five-second counting down.

(1) After automatic stage starts, the robot completes the automatic missions in the automatic mission area by running the automatic program. During this period, the contestant can send restart request to the referee.

(2) After automatic stage starts, the alliance can apply for switching the stage from the automatic to the manual stage. Once the competition switches to the manual stage, robots are not allowed to go back to the automatic mission area. The alliance has only one chance to apply for a stage switch, in which the alliance both agree to proceed to the Manual stage. The alliance shall apply for switching the stage to the manual mission area from referees and with the referees' permission, the match will move on to the scoring time after the automatic stage.

(3) The duration of this stage is 0 ~ 240 seconds, and the specific duration depends on the stage shifting application initiated by the alliance.

Scoring time after automatic stage

When the alliance applies stage switching and with the permission of the referee, the match will stop timing and enter the scoring time after the automatic stage. During



this period, the alliance can't contact their robots, the robots have to maintain the state under the stage switching application until the referee has completed the scoring.

Manual stage

After the referee completed the scoring of automatic stage, the referee issues the "transferring robots" command:

(1) Standing position: the contestants shall stand according to the position requirements in "**6.3 operation**".

(2) Robot position transfer: the red and blue team can move their robots in the automatic mission area to the starting area in the manual mission area.

After the robots placed, the referee will issue the command "**manual stage start**", the manual stage will start and the alliance can complete the manual mission.

(3) During the manual stage, the contestants shall divide the missions of the observer and the operator, and stand in the designated station area to complete the relevant missions. For specific standing requirements, please refer to the correct position of the contestants in "**6.3 operation**". In the manual stage, the observer and operator can apply to the referee for roles transposition. For specific transposition requirements, please refer to the correct transposition of contestants in "**6.3 operation**".

(4) If the alliance applies to the referee to end the match before the match time, referee gives the instruction of "over" and stops the timing, the match will end ahead of schedule; Or when the 4 minutes run out, the referee will take the initiative to issue the command of "end of match".

During the whole competition, the contestants can repair and modify the robot according to the rules requirements, and the match time will not stop during this period. Except for safety issues, the contestants shall not apply to the referee for suspension of the match.

Referee's Scoring and Contestant's Results Confirmation and Sign

The referee will count the scores after the competition. If there is no objection to the

competition, the captains of both alliances must confirm the match's result. If there is any doubt about the result, the captain of the alliance may appeal to the referee without signing on the score sheet.

After results confirmation, contestants shall actively assist the referee to restore the props, and leave the arena with their robots and Bluetooth controller in an orderly manner.

5. Technical Requirements

5.1 Robot General Specification

The Robot General Specification are prepared for better preparation for teams and ensures a fair and safe competition standard. We suggest team to programming and construct the robot under a fully comprehensive understanding of this specification. All robots must follow the Robot General Specification strictly and any against of the requirement will be asked to rectify. The robot might be disqualified if seriously against the specification.

Robot Mechanical Specification

T01. Each team can use only one robot for inspection. After inspection, the team can only use the inspected robot for the match. The team should not replace the robot or use a robot which is not inspected.

T02. During single match, some parts can be replaced except for, main-board, chassis, wheel or tracks.

T03. During the single match, the size of robot shall not exceed the size of: length 280mm, width 280mm, height 300mm. The diameter of the wheel (included the rubber tires) shall not exceed 70mm.

a. Size of robot is defined at the maximum extension state. Robot should be inspected when all movable structured is at extreme state (including the state after modification)



b. When robot is at extreme state, any structure shall not exceed the size of 280mm(width)*280mm(length)*300mm(height).

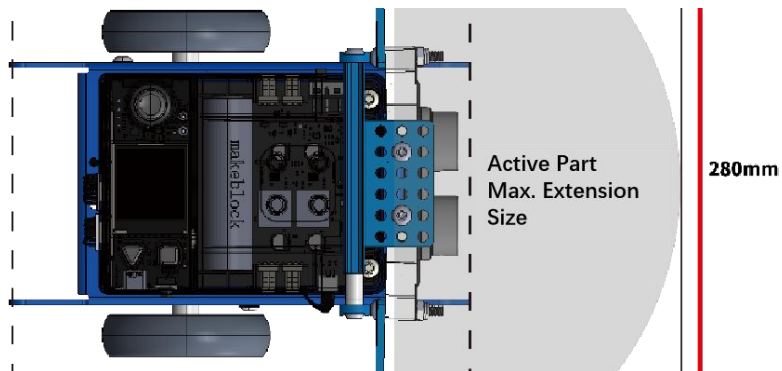

Figure 5.1-1 Maximum extension state (Side View)

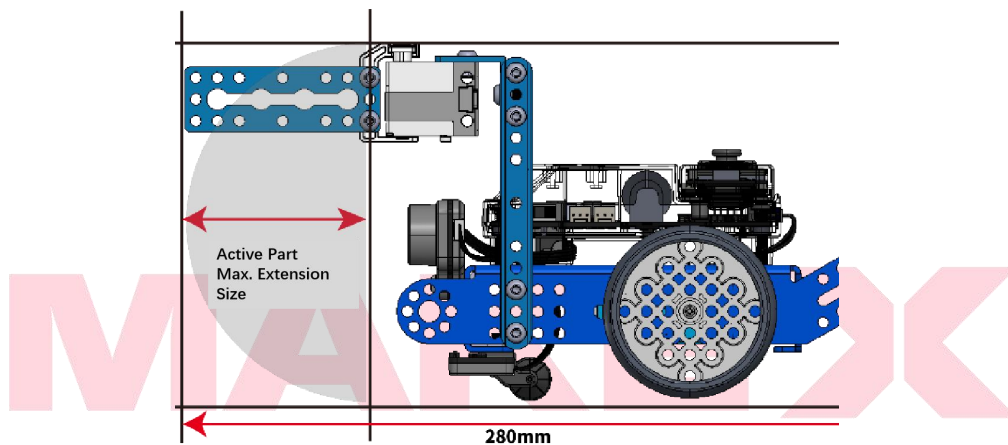

Figure 5.1-2 Maximum extension state (Top View)

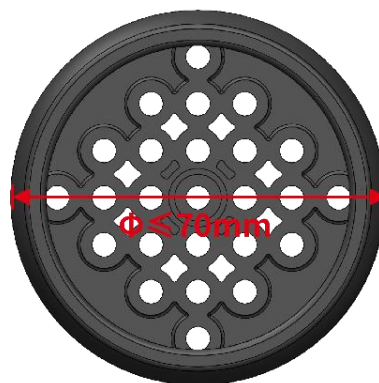

Figure 5.1-3 Wheel Size

T04. During the whole competition, robot weight should not exceed 2.5kg at any time, including weight of battery and other modification parts but not team marker.

T05. Teams can use self-made mechanical parts by 3D printing or laser cutting. Teams must not use commercial structures with mature design, including but not limit to



multi-DOF robotic arms or hands.

Robot Electronic Requirements

T06. To ensure the fairness of competition and prevent from team use high performance devices, team should use device which performance not over the following given specifications:

Device Type	Parts Name	Specs	Remark
Main-board & Extension Board	ESP32-WROVER-B	Processor: Xtensa® 32-bit LX6 Dual-Core Communication Mode: Console:Main-board to Extension Board Digital Signal: Smart Servo port PWM: DC Motor port	
Sensor	Vision Sensor	View angel: 65.0 degrees Valid focus: 4.65 ±5% mm, Refresh rate: 60fps Working distance: best in 0.25-1.2m Power Source: 3.7v lithium battery or 5v mBuild Power module Power range: 0.9w-1.3w	Types and quantities are not limited. Robots are prohibited from using any sensors that can interfere with the sensory capabilities of other robots
	Ultrasonic Sensor	Voltage: DC 5V Working distance: 5-300cm Error: ±5%	
	Line Follower	Voltage: DC 5V Working height: 5mm-15mm	
Motor & Servo Motor	Encoder Motor	180 Optical Encoder Motor Voltage: 12V Zero Load RPM: 350±5% Gear Ratio: 39:6	Must not modify any motor or servo internal mechanical and electrical design. Maximum total amount is 6.
	DC Motor	Dual-shaft TT motor Voltage: DC 6V Zero Load RPM: 200±10% Gear Ratio: 1:48	
		Highspeed TT motor Voltage: DC 6V Zero Load RPM: 312±10% Gear Ratio: 1:48	



	Smart Servo	MS-1.5A smart servo motor Voltage :4.8-6V DC Torque: 1.5kg/CM 9g small servo Voltage: 4.8-6V DC Torque: 1.3 -1.7kg/cm	
Wireless Communication	Bluetooth Controller	Frequency:2402-2480MHz, Antenna Gain: 1.5dBi, Working Current 15mA	
	Bluetooth Module	Bluetooth Version: BT4.0 Frequency:2402-2480MHz Antenna Gain: 1.5dBi Power: ≤4dBm Working Current: 15mA	Must not connect with any device other than Official Blue-tooth Controller. Including but not limited to manually trigger sensor.
Battery	18650 Battery	Configuration: 3.7V 2500mAh Output: 5V 6A	Must not be modified. Team should be responsible for any accidents for the modification.

Robots should comply with technical requirements. Any violate will be disqualified from the competition and team must modify the robot until match the requirements.

5.2 Team's Marker Specification

The specification of Team's Marker are below:

T07. The self-made prop should be a 3D structure without material limit. It is suggested to be fabric with laser cutting machine or 3D printer. The height should be over 120mm and the vertical projection of the prop should within a circular area of 60 mm in diameter.

T08. The prop is aiming to show the spirit of the team. MakeX Robotic Competition Committee encourages teams to use personalized or designed patterns, letters, characters but must be in a positive manner, in overall, representing the team culture, theme or competition. The content must follow the local law or regulations and



referee has the right to reject the prop during the inspection.

The team's marker must pass the inspection and pre-match check before bringing to the arena.

6. Rules of Competition

6.1 Penalty explanation

Explanations and categorization of penalties are defined in following sections:

Violation

E01. The referee immediately announced the violation to the team and deducted 20 points from the team as soon as it found a violation. During the violation, the competition will be timed normally.

E02. During the competition, if any scoring advantages are obtained because of the violation behavior, the scoring advantages will be invalid, and the scoring props will become an invalid prop.

Invalid Prop

E03. From the moment that have non-compliant contact with the mission prop and scoring prop, it will trigger the invalid prop and the referee will announce the props are invalid props. The invalid props will be removed from the arena by the referee and cannot continue to get points. The referee has the right to determine whether the final state of the prop before invalid can be scored or not according to the contents of to rule guide. At the scoring time, if the prop is contact with robot directly, the prop cannot be scored.

Disqualification from the single match

E04. During the match, the team violated the rules, resulting in invalidate of the score of the match, but did not affect another match.

Disqualification of the entire competition

E05. The team will lose the opportunity to continue to participate in the competition

and the right to get award. Scores of the entire competition will be disqualify.

6.2 Safety

Robot Safety

R01. The team's design and construction for robot should follow the technical requirements.

R02. All parts of the robot should be used safely.

R03. The robot should not behave any active behavior of parts separation (bouncing or shooting a parts).

R04. During the competition, the robot should not use any material to stick the arena props (including but not limited to double-side tape or glue).

R05. Referee has the right to reject a dangerous robot for competition. Referee has the right to disqualify a team for the entire competition depending on the dangerous level of the robot.

Team's Safety

R06. Under the guide of the mentor and after reading this guide, contestants can proceed to prepare for the competition and to design and construct their robot.

R07. In the preparation process, the team shall not perform any dangerous action.

R08. The Team should pay attention to safety when using dangerous tools (screwdrivers, sharp knives) and must use under the guide of their mentors.

R09. During the competition, contestants with long hair should tied it up; teams are prohibited from wearing slippers into the competition arena.

R10. During the competition, teams should not press the arena heavily or any behavior like damage the arena or props.

The referee has the right to reject the teams that do not conform the safety rules to enter the competition arena. The referee has the right to disqualify the score of a team for entire competition according to the level of danger.



6.3 Operation

Contestant standing position and switching rules

R11. During the whole match, the contestants shall standing in the designated area to finished the match. During the automatic stage, the contestants have to stand in the designated area at the automatic mission area. During the manual stage, an operator and an observer for each team are required to stand in the area shown in below figure. Contestants are not allowed to compete the competition out of the operation area. If a team only has one contestant, the contestant can choose only one role. The contestant cannot act in two roles at same time. (eg. operator cannot use controller in observation area and control robot) The dimension of area may vary according to the actual size of the competition venue.

R12. In the manual stage, if the operator and the observer need to exchange their roles, they should apply to the referee and announce, “Red/Blue Team switch role”. After the Referee responds, “Agree Red/Blue Team to switch”, the current operation should be stopped, and the contestants go to the correspondent operation area to continue the competition. During the switch of roles, the competition will be timed normally. When the operator applying to switch as an observer, he/she shall firstly put down the blue-tooth controller at the starting area before go to the observer area.

- Violation will be issued for the following behaviors: during the manual stage, contestant switch roles without the referee’s permission; after apply to switch role, the operator change position with the blue-tooth controller; during the manual stage, contestants operate their robot with blue-tooth controller at the observer area.

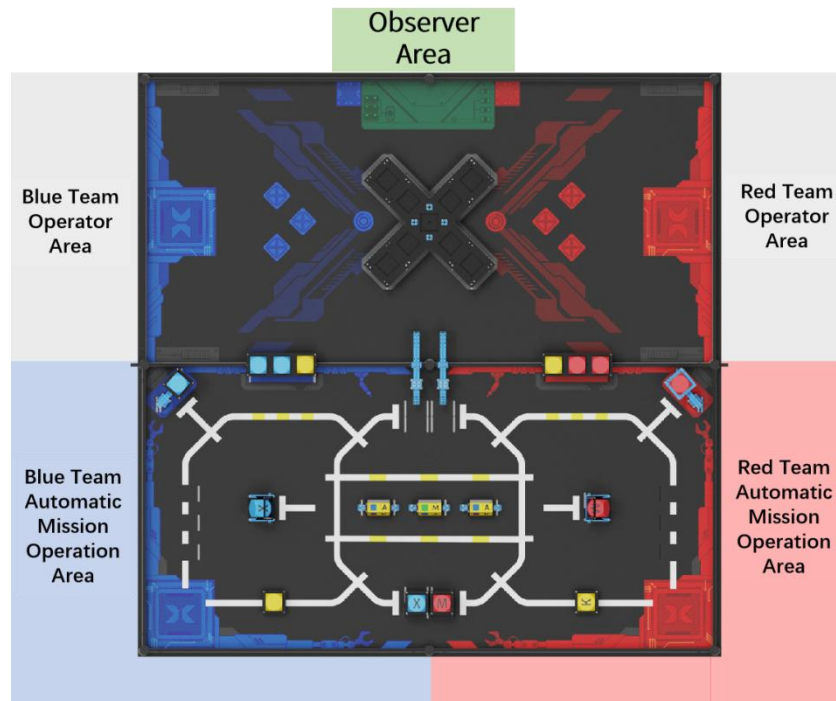

Fig 6.3-1 Contestant Operation Area

Robot Start, Restart & Modification Rules

R13. Contestants shall activate their robot after the referee announces the start of the competition. If the robot is moved in advance, the robot will be treated as “robot start in advance”. The robot have to be completely in the starting area when starting.

R14. During the competition, the contestants can restart and modify the robot at any time by applying to referee. With the referee’s permission, the contestant can restart and modify their own robot. Competition timing will not stop during the restarting or modification.

R15. If the Contestants choose to restart or modify their robot, the contestant of the Red/Blue Team should raise his/her hand to the Referee and announce, “Red/Blue Team requests Restart”. After the Referee responds, “Agree Red/Blue Team to Restart”, the robot can be taken out by contestants for restart or modification. The team can’t restart their robot with the referee’s permission.

R16. During the automatic stage, the contestant can contact their robots directly with the referee’s permission. During the manual stage, only the operator can contact the robot directly after the referee’s permission.

R17. After restart or modification, the robot shall start from the starting area, and

shall completely enter in the starting area.

R18. The modification area are the starting area and out of the arena.

R19. If the robot is located in an area that is out of the reach of the contestant, the contestant may raise his/her hand to the referee and call out "Red/Blue request the referee to pick up the robot" and the referee will pick up the robot on his/her behalf, and the team will be responsible for the penalties for any infractions that occur as a result of the referee picking up the robot on his/her behalf.

- Violation will be issued for the following behaviors: robot start in advance; starting the robot without being completely in the starting area; restarting or modifying the robot without requesting it from the referee; failing to modify in the modification area; during the manual stage, the observer directly or indirectly contact the robot.

Rules about competition props

R20. In the whole process of single match, the vertical projection of scoring prop should not completely leave the arena at any moment. Otherwise, the prop is invalid and cannot be place back in the arena.

R21. Contestants are allowed to direct or indirect contact the cube props that fully in the manual loading area.

- Direct contact: any part of a contestant's body (including hair, hands, etc.), hanging accessories, or identification that exists in contact with the props on the arena is considered direct contact;
- Indirect contact: when a contestant has contact with a robot, there is physical contact between the robot and the props.
- Violation will be issued for the following behaviors: during the match, the contestant directly contacts the scoring props or mission props on the arena; when the contestant applies for a restart to pick up the robot, there is physical contact between the robot and the props at the same time as the contestant has contact with the robot, i.e., the team member is indirectly contact the scoring props or mission props;



- Invalid prop will be issued for the following behaviors: during the match, the contestant directly or indirectly contacts the scoring props, and the scoring props that were contacted will be invalidated and removed from the arena.

Robot activity area during the competition

R22. During the automatic stage, robot should complete the missions in the automatic mission area, the vertical projection of the robot can partially in the manual mission area. During the manual stage, robot should complete the missions in the manual mission area, the vertical projection of any part of the robot shall not completely or partially in the automatic mission area.

R23. In automatic stage, robot can operate at its own area and alliance mission area.

- Violation will be issued for the following behaviors: during the manual stage, the vertical projection of the robot completely or partially enters the automatic mission area; during the automatic stage, the robot completely enters the alliance mate's independent mission area.
- Disqualification from the single match will be issued for the following behaviors: during the automatic stage, the robot enters the alliance mate's independent mission area and refuse to restart the robot; during the automatic stage, the robots repeatedly(3 times and over) enters the alliance mate's independent mission area

Using electronic communication devices and programming tools during the competition

R24. Contestant is only allowed to use the Bluetooth controller to control their own robot during the manual stage.

R25. Contestants are not allowed to bring computers, Tablet PC or any other programming devices into the competing area; during the competition time, teams are not allow to use electronic communication devices(include but not limit to mobile phone, intercoms)

- Disqualification from the single match will be issued for the following behaviors: bringing programming devices into the competing area, and



refuse to send the devices out of the competing area or continuing to use it after the reminder of the referee; using the electronic communication device and refuse to stop the action after the reminder of the referee; during the automatic stage, using the blue-tooth controller to operate their robot.

Rules about arena during the competition

R26. During the competition, contestant shall not deliberately press or hitting the arena.

R27. During the competition, contestants, robots are not allowed to destroy the arena elements on purpose.

- Violation will be issued for the following behaviors: deliberately press or hitting the arena; destroy the arena elements on purpose;
- If any scoring advantage is gained as a result of this infraction, the score is invalid and the scoring prop associated with the act will be removed from the arena.

Arrival the Arena on Time

R28. Teams should arrive at the competition area on time according to the actual competition schedule. If the whole competition schedule changes, please refer to the actual notice on-site.

- Disqualification from the match will be issued for the following behaviors: team that not show up in the competing area more than 5 minutes of the actual competition schedule.
- Disqualification of the entire competition will be issued for the following behaviors: the team unable to participate the competition after on-site registration and robot inspection. The match that the team is involved will continues as usual

External Mentoring

R29. During the whole process of the competition, the team should not have any external mentoring.



- Penalty for this behavior: Warning for the first time, violation for the second time. The team can be disqualified from single match if serious.

Egregious Behaviors

R30. It will be regarded as Egregious Behaviors if a Team or a person related with the team incurs into, but not limited to, any of the following circumstances. In case of Egregious Behaviors happens, the referee has the right to disqualify the score of entire competition.

- Impolite behaviors (abuse, bad words, unnecessary physical contact).
- Seriously affecting the competing area and the safety of the audiences. Interfering the process of competition.
- Seriously violating the spirit of competition (e.g., cheating).
- Repeated violations or ignoring the Referee's warning, violating blatantly.
- Malicious Complaints

Abnormal Situation

R31. Including but not limited to following situation:

- Potential Safety Risk: The competition venue emerges problems that might affect the safety of competing areas, teams or Robot.
- Damage or missing of Arena elements and props: The arena and its elements and props are damaged or missing accidentally which leads to the competition not continuing.
- Re-competition: Referees have the right to discuss and determine if a Re-competition is necessary according to the specific situation.

The uncertainty of arena, props

R32. Due to the uncertainty of manufacturing and processing, all arenas and props may exist minor error (dimension, weight, color and flatness, etc.). Teams should take these minor errors into consideration when constructing their robots to adapt different props and arenas. Contestants can apply to change the props before the competition if there are some adaptable props available. Robots should be able to adapt some unchangeable elements such as folded arena, light change, etc., The

team should debug their robot to adapt these unchangeable elements.

7. Appeal and Arbitration

7.1 Results Confirmation

Results Confirmation

When a single match ends, after the referees finished the scoring, the captains of both teams need to confirm the results with the referees and then sign on the score sheet. Both teams shall not have any objection to the results of this single match after their signatures.

Dispute Settlement

If have any objection to the results and referee's explanation, they can reject to sign the score sheet. Instead, they need to write clearly about the situation on the signature part of the score sheet.

7.2 Appeal Procedure and Valid Appeal Period

Appeal Procedure

Appeals should be lodged within the “valid appeal period” by the prescribed procedure and follow the civil participation spirit. The captain of the team needs to fill in the Appeal Form, then cooperates with the Arbitration Commission to investigate the actual situation. During the investigation, only the appealing contestants or the designated teams are allowed to cooperate. The Arbitration Commission has the right to communicate with the appealing party alone, avoiding the mentor, the parents of the contestants, their relatives, or friends. The appellant should express facts clearly and objectively, not being over-emotionally.

Valid Appeal Period

Normally, the appeal should be lodged within 30 minutes after the end of the



appealing match. Please check the Competition Guide for a specific effective appeal period before the competition. The appellant and the respondent must be present at the designated place on time.

Appeal Response

Not all the appeal will be accepted, the Arbitration Commission have the right to determine whether to accept the appeal or not according to the actual situation. Normally, the Arbitration Commission responds to the appeal after the end of the competition on the same day or before the start of the competition on the next day.

7.3 Invalid Appeal

Overdue Appeal

Appeals that are not lodged within the "valid appeal period" will be considered invalid and inadmissible. If the appellant fails to be present on time or leaves without any reason during the investigation, the appeal will be considered invalid. If the respondent fails to be present on time, the Arbitration Commission will directly determine the arbitration result and render it as a final result.

Appellants out of Stipulation

The appellants must be the participating contestant and the appeal of another person is inadmissible. The Arbitration Committee will caution the offending team if parents, mentors, or other persons out of the stipulation participate in the arbitration process without the permission of the Arbitration Committee.

- Penalty for this behavior: Warning for the first time, a disqualification will be given for multiple invalid warnings.

Vague Appeal's Requests

If the Arbitration Commission is unable to understand the appeal or conduct the normal investigation due to emotion factor of the appealing party, the offending party will receive a verbal warning.

- Penalty for this behavior: Warning for the first time, a disqualification will be given for multiple invalid warnings.

Uncivil Appeal

Neither side shall make uncivil behavior nor offensive action and remarks.

- Penalty for this behavior: Warning for the first time, a disqualification will be given for multiple invalid warnings.

7.4 Arbitration Procedure

Arbitration Procedure

The Arbitration Commission consists of the head referee, the arbitration consultant, and the competition technical head. The Arbitration Commission is responsible for accepting the appeals and conducting arbitration investigations, to ensure the smooth progress of the competition and the fairness and justice of the competition results. The playback videos and photographs of any competition may be inaccurate due to the shooting angle, which is only used as reference but not arbitration evidence.

Arbitration Results

The arbitration results can be divided into “maintaining the original result of the match” or “re-match”, and the two teams shall not appeal again. If the arbitration result is a "re-match", the two teams shall have a re-match according to the time and arena stipulated in the Appeal Form. If either team fails to reach the arena within 5 minutes after the beginning of the match, the team shall be deemed to quit the match.

Additional Remarks

The Arbitration Commission determines the final arbitration result, and neither side shall dispute the result of the appeal anymore.

8. Statement

The official language for MakeX is Chinese. English or other language translations are prepared to facilitate the Team's preparation process. All documents translated to English are for reference only.

The MakeX Robots Competition Committee reserves the final interpretation of MakeX Robots Competition - Rules Guide for All-Core Journey.

8.1 Rules Explanation

In order to ensure a fair competition and high-quality competition experience, MakeX Robotics Competition Committee has the right to update and complement this Rules Guide regularly, issue and implement the latest version before the competition.

During the competition, all matters not stated in the Rules Guide shall be decided by the referee team.

This Rules Guide is the basis for refereeing, and the referee team has the right of adjudication during the competition.

8.2 Disclaimer

All Contestants in MakeX Robotics Competition should fully understand that safety is the most important issue for the sustainable development of MakeX Robotics Competition. To protect the rights and interests of all contestants and organizers, according to relevant laws and regulations, all contestants registered for the MakeX Robots Competition, should acknowledge and abide by the following safety provisions:

- (1) Contestants should take adequate safety precautions when constructing the robots, and all parts used for constructing the robots should be purchased from legal manufacturers.



- (2) Contestants should ensure that the structural design of the robots takes into account the convenience of the inspection and actively cooperate with the host of the competition.
- (3) When modifying and using the parts with potential safety hazards for the Robots, it must conform to the national laws, regulations and quality & safety standards. Those operations should be manufactured and operated by persons with relevant professional qualifications.
- (4) During the competition, the teams should ensure that all the actions such as construction, testing and preparation will not do harm to their own team and other teams, referees, staff, audiences, equipment and arenas.
- (5) In the process of construction and competition, if any action that may violate the national laws, regulations or standards occur, all consequences will be borne by the contestants themselves.

The competition kits and parts sold and provided by the supporter, Shenzhen Makeblock Co., Ltd., shall be used by the instructions. Shenzhen Makeblock Co., Ltd. and MakeX Robotics Competition Committee will not be responsible for any injury or loss of property caused by improper use.

8.3 Copyright Declaration

Shenzhen Makeblock Co., Ltd. reserves the copyright of this Rules Guide. Without the written consent or authorization from Shenzhen Makeblock Co., Ltd, any entity or individual may not reproduce, including but not limited to any network media, electronic media or written media.

Appendix 1. Awards and Annual Points

According to competition scale and team number, the competition will be classified into Points Race/Regional Competition, National Competition, International/Intercontinental Competition, and World Championship. Each team can voluntarily sign up for all kinds of Points Race all year round to accumulate the annual points. The accumulation of annual points is based on the Team Number. The plan of annual points for MakeX Starter is as follows:

Teams who participate in the single Points Race can obtain annual points = (total point in all qualification round + total score of the best single match in the championship round)* competition type coefficient

Competition Level	Rank Coefficient
Points Race/Regional Competition	Sum of Scores*0.01
National Competition	Sum of Scores*0.02
International/Intercontinental Competition	Sum of Scores*0.03

Teams that have won the champion, runner-up, second runner-up and other awards can obtain additional annual points. For the details of award list, please refer to

MakeX Awards Guide.

Category	Awards	Regional /Points Race	National	International/ Intercontinental
Special Award	Champion	15	30	45
	Runner-up	10	20	30
	Second runner-up	5	10	15
	Innovative Design Award	-	5	10
	Engineering Notebook Award	-	5	10
Comprehensive Award	Outstanding Mentor Award(personal)	-	-	-



	Promotion Ambassador Award(Group)	-	5	10
	Technology Sharing Award(Group)	-	5	10
	MakeX Spirit Award	-	-	10

Take a 4+1 point race as an example (4 rounds in Qualification, 1 round in Championship), if team X10000 wins the championship and all the match results show as below:

Qualification Round 1	Qualification Round 2	Qualification Round 3	Qualification Round 4	Total Points in Qualification Round
300	200	400	350	1250
Total Points in Single Championship				
500				

*Annual points that team X10000 can obtain from this competition = (1250+500)

*0.01+15 = 32.5

MAKE X

Appendix 2. Engineering Notebook Guideline

*Instruction:

1. The value of engineering notebook: It helps the team establish files and record the whole learning process. Therefore, it is necessary to record engineering notebook during the entire preparation for the competition.

2. Engineering notebook submission: Teams can use online documents or handwriting. No matter which way to use, each team must submit a paper version onsite.

Paper engineering notebook: As the Challenge & Premier programs require the assessment process, one copy of the paper version shall be submitted by each team to the judges onsite. If there is no assessment process (Starter & Explorer), each team will need to submit one copy of the paper version to the staff at the inspection area. Teams that cannot submit the original engineering notebook should prepare their own copies.

3. An engineering notebook will be required for the evaluation of all technical awards. Please refer to the MakeX Awards Guide for the evaluation criteria.

Basic Requirements for Cover

The team's name, team number, and competition program must appear on the cover of the engineering notebook.

Basic Requirements for Contents

1. Clear content

Creating content brings convenience for the judges to review and quickly find the corresponding section.

2. Process records (Mandatory)

Every improvement of the robots should be recorded from prototype design, construction, to the debugging. Keep pictures of all manuscripts, design drawings, calculation processes, circuit diagrams, etc., and insert them into the engineering notebook in the form of pictures.



- 1) Schedule of robot building progress
- 2) Design inspiration/sketch
- 3) Technical principle (it can be disassembled into different parts)
- 4) Production step by step (with clear pictures)
- 5) Problems encountered and solutions

Examples of problems:

What technical failures did you encounter? Why did you fail? How did you solve the problems finally?

What efforts have you made for the robots? What improvements have been achieved?

Does your project progress schedule go as planned? What accidents or delays have occurred? How to fix it?

Have there been any disputes among the team members and how to settle them in the end?

3. Projects summary

- 1) The structure and function of the project (with pictures and text enclosed)
- 2) The technical innovations of the project
- 3) Competition strategies for scoring and defense

4. Team introduction

- 1) A brief biography of each team member and their role on the team
- 2) Culture displaying (logo, team flag, slogan, posters, T-shirt, etc.)
- 3) Excellent achievements sharing (Stories)

5. Feelings and other things you want to share (optional)

- 1) Achievement in the competition (Technical)
- 2) Growth in the competition (Spiritual)
- 3) Suggestions for competition

Appendix 3. Robot Self-Check Form

MakeX Starter All-Core Journey Robot Self-Check Form

Please follow the requirements of the self-checklist and check the box if your robot meets the requirements. And submit the signed self-checklist during the inspection day. Thanks for your cooperation.

Team Number: _____ Team Name: _____

Actual attended Team Member: _____

Mentor Name: _____

1. Basic Information
Robot Mainboard Number: _____ (A 12-bit code consist of numbers and alphabet, please find in the "Setting" section from the CyberPi)
Robot Size: Length _____ mm, Wide _____ mm, Height _____ mm. (Robot size should not exceed: length 280mm, width 280mm, height 300mm. Please measure your robot and fill in the actual maximum extension size)
Robot Wheel Diameter: _____ mm (Should not exceed 70mm)
Robot Weight: _____ kg (Should not exceed 2.5kg)
Team Marker: Length _____ mm, Wide _____ mm, Height _____ mm. (Height \geq 120mm, vertical projection of the prop should be within a diameter of 60mm square area)
2. Equipment
Name and quantity of sensors:
Name and quantity of motors:
Name and quantity of servos:
Wireless control: Version of Bluetooth: BT4.0 <input type="checkbox"/> Yes
Name and parameters of battery: (18650 Lithium-ion , 3.7V 2500mAh) <input type="checkbox"/> Yes
3. Others



No.	Items	Specific Requirements	Meet required States
1	High-power Equipment	Dangerous high-power equipment is not allowed to be used by the Teams during the competition and the preparation of the competition.	<input type="checkbox"/> Yes
2	Energy Storage Device	If robot is using any energy storage device for operation, safety must be ensured at the first place.	<input type="checkbox"/> Yes
3	Safety and Protection	Any structures that may hurt human during the operation must be protected with appropriate manners.	<input type="checkbox"/> Yes
4	Damage of Arena	Any robot operation must not damage the arena.	<input type="checkbox"/> Yes
5	Forbidden Materials	Robot must not use flammable gas, fire hazard materials, hydraulic structures, mercury content parts, explosive materials, dangerous counterweight, structures may cause entangle with another robot, sharp edge parts, liquid or sticky materials or any electrical leakage device or materials.	<input type="checkbox"/> Yes
6	Self-made Parts	Teams can use self-made parts by 3D printing or corrugated cardboard, woods, acrylic and Rubber band, etc. All self-made parts cannot have producers' logo.	<input type="checkbox"/> Yes
7	Mechanical Parts	Teams can use self-made mechanical parts by 3D printing or laser cutting. Teams must not use commercial structures with mature design, including but not limit to multi-DOF robotic arms or hands.	<input type="checkbox"/> Yes

Our team has checked our own robot according to the self-check form and has filled in the actual data on this form and submitted it to MakeX Robotics Committee. We promise that we will participate in the competition in the above state and will report any changes in time. During the competition, if the robot does not comply with the requirement or our team uses any in-compliance robot, the competition result will be disqualified and all responsibilities will be taken by the team without objection.

Team Leader Signature:

Date:



Appendix 4. MakeX Starter Score Sheet

MAKE X

2024 MakeX Robotics Competition MakeX Starter All-core Journey
[Qualifications Round] Scoring Sheet

Match Information _____ (Arena No.) _____ (Session)

Red Team No. (_____) Blue Team No. (_____)

Independent Mission			Alliance Mission	
Red Team	Blue Team			
(20Points/Each)	1. Yellow (Alphabet) Cube & its base[Move out of initial area]	(20Points/Each)	7. Sequence of rotary cylinder as "A, K, E" or "E, K, A"	(30Points/Each)
(30Points/Each)	2. Yellow (Alphabet) Cube & its base[In the manual area]	(30Points/Each)	8. Red/Blue Alphabet Cube[by correct color&sequence]	(20Points/Each)
(30Points/Each)	3. Red/Blue Alphabet Cube[In the manual area]	(30Points/Each)	9. MakeX Bonus	(50Points/Set)
(20Points/Each)	4. Red/Blue Alphabet Cube[move out of the high table]	(20Points/Each)	10. Team Marker[fully in the marking area]	(30Points/Each)
(10Points/Each)	5. Red/Blue Alphabet Cube["X" or "M" face up]	(20Points/Each)	Alliance Mission Score	
(20Points/Each)	6. Yellow Cube [In the initial area]	(20Points/Each)	Red Team Penalty	Blue Team Penalty
Independent Mission Score				

Single Match Score		Red Team Signature	
Red Team	Blue Team		
Independent Score	Independent Score		
Penalty Score	Penalty Score		
Alliance Score		Blue Team Signature	
Total Score	Total Score		
Total Competition time: Minutes Seconds		Referee Signature	

MAKE X

MAKE X

2024 MakeX Robotics Competition MakeX Starter All-core Journey
[Championship Round] Scoring Sheet

Match Information _____ (Arena No.) _____ (Session)

Team 1 No. (_____) Team 2 No. (_____)

Independent Mission			Alliance Mission	
Red Team	Blue Team			
(20Points/Each)	1. Yellow (Alphabet) Cube & its base[Move out of initial area]	(20Points/Each)	7. Sequence of rotary cylinder as "A, K, E" or "E, K, A"	(30Points/Each)
(30Points/Each)	2. Yellow (Alphabet) Cube & its base[In the manual area]	(30Points/Each)	8. Red/Blue Alphabet Cube[by correct color&sequence]	(20Points/Each)
(30Points/Each)	3. Red/Blue Alphabet Cube[In the manual area]	(30Points/Each)	9. MakeX Bonus	(50Points/Set)
(20Points/Each)	4. Red/Blue Alphabet Cube[move out of the high placing table]	(20Points/Each)	10. Team Marker[fully in the marking area]	(30Points/Each)
(10Points/Each)	5. Red/Blue Alphabet Cube["X" or "M" face up]	(20Points/Each)	Alliance Mission Score	
(20Points/Each)	6. Yellow Cube [In the initial area]	(20Points/Each)	Alliance Penalty Record	
Independent Mission Score				

Single Match Score		Red Team Signature	
Red Team	Blue Team		
Independent Score	Independent Score		
Penalty Score	Penalty Score		
Alliance Score		Blue Team Signature	
Total Score	Total Score		
Total Competition time: Minutes Seconds		Referee Signature	

Appendix 5. Competition Resources

Competition resources include but are not limited to official resources provided by the committee, such as Competition Guide, Equipment Instructions, Rules Videos, etc.

The contestants are obliged to keep abreast of the update of competition resources before the competition, and any problems caused by the contestants' failure to keep abreast of the updates shall be borne by the contestants themselves. All official competition resources will be updated in MakeX Website.

MakeX Robotics Competition Committee will revise and improve the Rules Guide with the progress of the competition and the new version will be announced in MakeX Website. The contestants and mentors can download the latest version in MakeX Website.

MakeX Website Download <https://www.makex.cc/en/information/download>.

MakeX Official Website: <https://www.makex.cc/en>.

Any Feedback & Question Please Sent to:

makex_overseas@makeblock.com

MAKE X

Edited By Makex Robotics Competition Committee

RULES GUIDE

MAKEEX STARTER

Official Website:
www.makex.cc/en

Email:
makex_overseasa@makeblock.com

 Facebook : Makex